

Operating Instructions Air Conditioner

Middle Static Pressure Duct (Type F3)

<At horizontal installation>

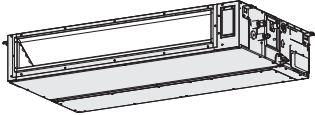

<At vertical installation>

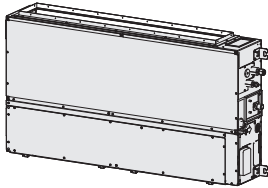

ENGLISH

Before operating the unit, read these operating instructions thoroughly and keep them for future reference.

Model No.

INDOOR UNIT

Middle Static Pressure Duct (Type F3)

S-15MF3E5AN	S-73MF3E5AN
S-22MF3E5AN	S-90MF3E5AN
S-28MF3E5AN	S-106MF3E5AN
S-36MF3E5AN	S-112MF3E5AN
S-45MF3E5AN	S-140MF3E5AN
S-56MF3E5AN	S-160MF3E5AN
S-60MF3E5AN	

- **Connectable outdoor unit lineup**
This booklet is the operating instructions for indoor unit. Regarding the outdoor unit, see the operating instructions supplied with the outdoor unit.

OUTDOOR UNIT

Refrigerant type : R410A
mini VRF (Type LE1, LE2)
2WAY VRF (Type ME2)
3WAY VRF (Type MF3)

Thank you for purchasing this Panasonic product.
 This product is a commercial air conditioner indoor unit.
 Installation Instructions attached.

Contents

● Safety Precautions.....	2
● Precautions for Use.....	5
● Names of Parts.....	6
<hr/>	
● Maintenance.....	7
● Operation Mechanism.....	7
● nanoe™ X Function.....	8
● Troubleshooting.....	9
• Before Requesting Services.....	10
<hr/>	
● Connectable Outdoor Unit.....	11
● Specifications.....	12
• Indoor unit.....	12
• Outdoor unit.....	15

Product Information

If you have problems or questions concerning your Air Conditioner, you will need the following information. Model and serial numbers are on the nameplate.





Model No.
Serial No.
Date of purchase
Dealer's address
Phone number

Important Information Regarding The Refrigerant Used

This product contains fluorinated greenhouse gases.
 Do not vent gases into the atmosphere.
 Refrigerant type: R410A
 GWP⁽¹⁾ value: 2088
⁽¹⁾GWP = global warming potential
 Periodical inspections for refrigerant leaks may be required depending on European or local legislation.
 Please contact your local dealer for more information.



Safety Precautions

The following symbols used in this manual, alert you to potentially dangerous conditions to users, service personnel or the appliance:

	WARNING	This symbol refers to a hazard or unsafe practice which can result in severe personal injury or death.
	CAUTION	This symbol refers to a hazard or unsafe practice which can result in personal injury or product or property damage.
	Prohibited matters	
	Matters to be observed	

- Read these Operating Instructions carefully before using this air conditioner. If you still have any difficulties or problems, consult your dealer for help.
- This air conditioner is designed to give you comfortable room conditions. Use this only for its intended purpose as described in these Operating Instructions.

! WARNING

	<p>Confirm to authorized dealer or specialist on usage of specified refrigerant type. Using of refrigerant other than the specified type may cause product damage, burst and injury, etc.</p> <hr/> <p>This air conditioner has no ventilator for intaking fresh air from outdoors. You must open doors or windows frequently when you use gas or oil heating appliances in the same room, which consume a lot of oxygen from the air. Otherwise there is a risk of suffocation in an extreme case.</p>
	<p>Never use or store gasoline or other flammable vapor or liquid near the air conditioner — it is very dangerous.</p> <hr/> <p>Do not use this appliance in a potentially explosive atmosphere.</p> <hr/> <p>Never touch the unit with wet hands.</p>
	<p>Do not insert your fingers or other objects into the air conditioner indoor or outdoor unit, rotating parts may cause injury.</p>

WARNING



If the refrigerant comes in contact with a flame, it produces toxic gases.

For safety, be sure to turn the air conditioner off and also to disconnect the power before cleaning or servicing.

Pull off the power plug from a receptacle, or switch off the breaker, or switch off the power disconnecting mean to isolate the air conditioner from the main power supply in case of emergency.



Dispose of according to national and/or local legislation.



This product must not be modified or disassembled under any circumstances.

Modified or disassembled unit may cause fire, electric shock or injury.

Do not clean inside the indoor and outdoor units by users. Engage authorized dealer or specialist for cleaning.

In case of malfunction of this appliance, do not repair by yourself. Contact the sales dealer or service dealer for a repair and disposal.



Provide a power outlet to be used exclusively for each unit, and a power supply disconnect, Earth Leakage Circuit Breaker (ELCB) or Residual Current Device (RCD) for overcurrent protection should be provided in the exclusive line.

Provide a power outlet exclusively for each unit, and full disconnection means having a contact separation in all poles must be incorporated in the fixed wiring in accordance with the wiring rules.

To prevent possible hazards from insulation failure, the unit must be grounded.



Do not use modified cord, joint cord, extension cord or unspecified cord to prevent overheating and fire.



Stop using the product when any abnormality/failure occurs and disconnect the power plug or turn off the power switch and breaker. (Risk of smoke/fire/electric shock)

Examples of abnormality/failure:

- The ELCB trips frequently.
- The product sometimes does not start when turned on.
- The power is sometimes disconnected when the cord is moved.
- Burnt odor or abnormal noise is detected during operation.
- The body is deformed or abnormally hot.
- Water leaks from the indoor unit.
- Power cord or plug becomes abnormally hot.
- Fan speed cannot be controlled.
- The unit stops running immediately even if it is switched on for operation.

Contact immediately your local dealer for maintenance/repair.



Do not sit or step on the unit. You may fall down accidentally.



CAUTION



This appliance is intended to be used by expert or trained users in shops, in light industry and on farms, or for commercial use by lay persons.

This appliance is not intended for use by persons (including children) with reduced physical, sensory or mental capabilities, or lack of experience and knowledge, unless they have been given supervision or instruction concerning use of the appliance by a person responsible for their safety. Children should be supervised to ensure that they do not play with the appliance.

<for European market only>

This appliance can be used by children aged from 8 years and above and persons with reduced physical, sensory or mental capabilities or lack of experience and knowledge if they have been given supervision or instruction concerning use of the appliance in a safe way and understand the hazards involved. Children shall not play with the appliance. Cleaning and user maintenance shall not be made by children without supervision.

Keep the fire alarm and the air outlet at least 1.5 m away from the unit.

Do not make the room too hot or too cold if babies or invalids are present.



Do not turn the air conditioner on and off from the power mains switch. Use the ON/OFF operation button.

Do not stick anything into the air outlet of the outdoor unit. This is dangerous because the fan is rotating at high speed.



Do not touch the air inlet or the sharp aluminum fins of the outdoor unit. You may get injured.



Do not stick any object into the FAN CASE. You may be injured and the unit may be damaged.



NOTICE

- The appliance shall be stored so as to prevent mechanical damage from occurring.
- The compressor may occasionally stop during thunderstorms. This is not a mechanical failure. The unit automatically recovers after a few minutes.
- The English text is the original instructions. Other languages are translation of the original instructions.

Precautions for Use

Installation

- This air conditioner must be installed properly by qualified installation technicians in accordance with the Installation Instructions provided with the unit.
- Before installation, check that the voltage of the electric supply in your home or office is the same as the voltage shown on the nameplate.

WARNING

Avoid the following locations for installation.

- Locations where smoke or combustible gas exists. Also locations of extremely high temperature such as a greenhouse.
- Locations where excessively high heat-generating objects are placed.

Attention:

- Avoid installing the outdoor unit where salty sea water can splash directly onto it or in sulphurous air near a spa. (To protect the air conditioner from heavy corrosion)

Wiring

- All wiring must conform to the local electrical codes. (Consult your dealer or a qualified electrician for details.)
- Each unit must be properly grounded with a ground (or earth) wire or through the supply wiring.
- Wiring must be done by a qualified electrician.

Operation Preparation

Turn the power mains on 5 hours before the start of operation.

(For warm-up)

- Leave the power mains ON for continuous use.

NOTE

Pull off the power plug from a receptacle, or switch off the breaker, or switch off the power disconnecting mean to isolate the air conditioner from the main power supply when not in use for a long time.

Tips for Energy Saving

■ Avoid

- Do not block the air intake and outlet of the unit. (If either is obstructed, the unit will not function well, causing malfunction.)
- During cooling operation, use sunshades, blinds or curtains to prevent direct sunlight from entering the room.

■ Do

- Always keep the air filter clean. (A clogged filter will impair the performance of the unit.)
- To prevent conditioned air from escaping, keep windows, doors and any other openings closed.

Disposal of Old Equipment

Only for European Union and countries with recycling systems



This symbol on the products, packaging, and/or accompanying documents means that used electrical and electronic products must not be mixed with general household waste.

For proper treatment, recovery and recycling of old products, please take them to applicable collection points in accordance with your national legislation.

By disposing of them correctly, you will help to save valuable resources and prevent any potential negative effects on human health and the environment. For more information about collection and recycling, please contact your local municipality.

Penalties may be applicable for incorrect disposal of this waste, in accordance with national legislation.

This air conditioner incorporates a biocidal product.



Free radicals generated by a device incorporated in the air conditioner have the capacity to inhibit pollutants, such as certain types of bacteria, viruses, mould.

Active substances : Free radicals generated in situ from ambient air or water.

Usage : This device function can be turned ON / OFF by the "nanoe X" icon button or remote controller settings if there is no "nanoe X" icon button. Please refer to "How to Use" for more details.

Names of Parts

INDOOR UNIT

Type F3 (Middle Static Pressure Duct)

At standard installation
(Horizontal installation in the ceiling, rear side air intake)

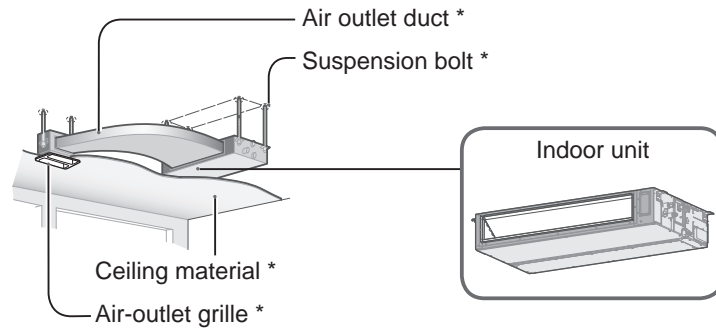

* Field supplied

OUTDOOR UNIT

mini VRF (Type LE1, LE2)
2WAY VRF (Type ME2)
3WAY VRF (Type MF3)

NOTE

Refer to the Operating Instructions attached to the outdoor unit.

Optional

Wireless Remote Controller



Model No.
CZ-RWS3

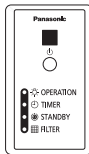

Model No.
CZ-RWRC3

(Infrared Remote Controller)

Timer Remote Controller



Model No.
CZ-RTC4

For all indoor
units

High-spec Wired Remote Controller



Model No.
CZ-RTC5B

For all indoor
units

Wired Remote Controller

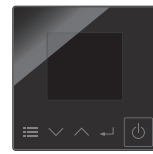

Black



White

Model No. CZ-RTC6 series
For all indoor units

Read the Operating Instructions included with the Remote Controller.

■ Operation & Adjusting Airflow Direction

Refer to the Operating Instructions attached to the Remote Controller.

Maintenance

WARNING

- For safety, be sure to turn the air conditioner off and disconnect the power before cleaning. (Otherwise, electric shock or injury may result because the fan is rotating at high speed.)
- Do not pour water on the indoor unit. (This may damage the internal components and cause an electric shock hazard.)

CAUTION

- Never use solvents or harsh chemicals. Also, do not wipe plastic parts using very hot water. (This may cause deformation or change in colour.)
- Some metal edges and fins are sharp. Be careful when you clean those parts. (Injury may result.)
- Use a firm stool or ladder when cleaning an indoor unit installed in high locations.

■ Outdoor unit

The internal coil and other components of the outdoor unit must be cleaned periodically.

- Consult your dealer or service center.

■ Air Filter Maintenance



When cleaning the air filter, consult your dealer or service center.

Operation Mechanism

■ Heating performance

- This air conditioner utilizes outside air for heating; its heating performance reduces as outside temperature decreases.
→ In the event that heating is not sufficient, please use an additional heating appliance.

■ Defrosting

- This appliance may start defrosting operation to melt frost formed in the outdoor unit.
 - ① **Defrosting starts:** The indoor unit fan stops (or the speed becomes extremely slow).
→ “” (STANDBY) appears.
 - ② **Heating operation resumes after several minutes:** The indoor unit fan remains stopped (or it will run at a very slow speed) until the indoor heat exchanger coil warms up sufficiently.
→ “” (STANDBY) appears.
 - ③ **Defrosting is complete:** The indoor unit fan starts operation.
→ “” (STANDBY) disappears.

■ “DRY” operation

- Once the room temperature reaches the level that was set, the outdoor unit repeats the cycle of turning on and off automatically.
- When the room temperature is more likely to reach the level that was set, the fan speed is set to “breeze” (light wind) automatically.

■ Should power failure occur while the unit is running

The unit will resume operation automatically. Operation settings prior to power failure will be used.

nanoe™ X Function

Display during operation of nanoe™ X

Example: Initial screen of remote controller

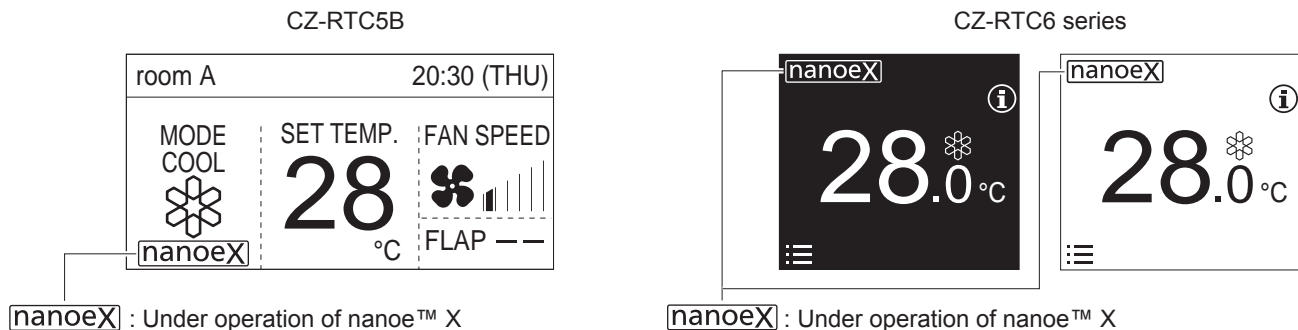

Definition of nanoe™ X

nanoe™ X particles are nano-sized electrostatic atomized water particles that contain hydroxyl radicals, which have beneficial effects.

nanoe™ X particles contain more hydroxy radicals than nanoe™ particles.

nanoe™ X For a freshness and cleaner environment

nanoe™ X generates negative ions using the air in the room to give a clean air.

It also reduces the smell in the room, and inhibits the proliferation of mold and bacteria.

When purchased, the nanoe™ X function is designed to operate automatically.

- If you wish to set to OFF, refer to the operating instructions for the remote controller adaptable to nanoe™ X function.

The effect of nanoe™ X may decrease slightly depending on the installation conditions of the unit.

Inhibiting indoor air pollutants and making fresh air



Troubleshooting

Check before consulting or requesting services.

Symptom		Cause / Action
Indoor unit	Noise Sound like streaming water is heard during operation or after operation. Cracking noise is heard during operation or when operation stops.	• Sound of refrigerant liquid flowing inside unit • Sound of drainage water through drain pipe
		• Sound due to temperature changes of parts
	Discharged air smells during operation.	• Indoor odor components, cigarette odor and cosmetic odor accumulated in the air conditioner and its air is discharged. • The unit inside is dirty. (Contact your dealer.)
	Dewdrops accumulate near the air outlet during cooling operation.	• Internal moisture is cooled by cool wind and accumulates as dewdrops.
	Fog occurs during cooling operation.	• If the air conditioner has been installed at places such as restaurants where large amounts of oil mist exist, cleaning is necessary because the unit inside (heat exchanger) is dirty. (Contact your dealer.)
	Fog occurs during heating operation.	• Defrost operation is in process.
	The fan is rotating for a while even though operation stops.	• The fan may rotate to dry the heat exchanger depending on the setting.
	Dust is discharged.	• Dust accumulated inside the indoor unit is discharged.
	At the initial high-speed operation, the fan sometimes rotates faster than the setting speed. (3 to 30 minutes)	• This is for operation check in order to confirm whether the fan motor rotation is within the range of use.
	Humming noise comes out.	• This is the sound of nanoe™ X being discharged.
	nanoeX is not displayed on the remote controller.	• Has nanoe™ X been set to OFF? → Set to ON.
	⚠ nanoeX is displayed on the remote controller.	• nanoe™ X is considered abnormal. (Contact your dealer.)
Outdoor unit	No operation (When the power is turned on immediately / When operation is stopped and resumed immediately)	• Operation is not activated for the first approx. 3 minutes because the compressor protection circuit is activated.
	Noise occurs during heating operation.	• Defrost operation is in process.
	Steam comes out during heating operation.	
	The fan continues to rotate even after the operation is stopped using the remote controller.	• This is for smooth operation.

Troubleshooting

Before Requesting Services

Symptom	Cause	Action
The air conditioner does not operate although the power is turned on.	Power failure or after power failure	Press the power ON/OFF button on the remote controller.
	The operation (power) button is turned off.	<ul style="list-style-type: none"> • If the breaker is turned off, turn the power on. • If the breaker has been tripped, consult your dealer without turning it on.
	Fuse blow out.	Contact your dealer.
Poor cooling or heating performance	The air intake or air outlet of indoor and outdoor units is clogged with dust.	Remove the dust.
	The fan speed switch is set to "Low".*	Change to "Medium" or "High".*
	Improper temperature settings	See "Tips for Energy Saving". (P.5)
	The room is exposed to direct sunlight in cooling mode.	
	Doors or windows are open.	
	The air filter is clogged.	Contact your dealer.
	Too many heat sources in the room in cooling mode.	Use minimum heat sources and in a short time.
Too many people in the room in cooling mode.	Lower the temperature setting or change to "Medium" or "High".*	

* Regarding the fan speed control display on the remote controller, see pages 12, 13, 14.

If your air conditioner does not work properly even after checking each item of "Before Requesting Services" and "Troubleshooting"

- Stop the operation immediately and turn the power off. Then contact your dealer and report the serial number and symptom. You also report if the inspection mark  and the letters E, F, H, J, L, P in combination with numbers appear on the LCD of the remote controller.
- Never repair the air conditioner by yourself since it is very dangerous for you to do so.

Connectable Outdoor Unit

Europe

Outdoor unit type		4 HP	5 HP	6 HP	8 HP	10 HP
LE2	1-phase	U-4LE2E5	U-5LE2E5	U-6LE2E5	–	–
	3-phase	U-4LE2E8	U-5LE2E8	U-6LE2E8	–	–
LE1	3-phase	–	–	–	U-8LE1E8	U-10LE1E8
ME2	3-phase	–	–	–	U-8ME2E8	U-10ME2E8
MF3	3-phase	–	–	–	U-8MF3E8	U-10MF3E8

Outdoor unit type		12 HP	14 HP	16 HP	18 HP	20 HP
ME2	3-phase	U-12ME2E8	U-14ME2E8	U-16ME2E8	U-18ME2E8	U-20ME2E8
MF3	3-phase	U-12MF3E8	U-14MF3E8	U-16MF3E8	–	–

Oceania

Outdoor unit type		4 HP	5 HP	6 HP	8 HP	10 HP
LE2	1-phase	U-4LE2R5	U-5LE2R5	U-6LE2R5	–	–
		U-4LE2R5E*	U-5LE2R5E*	U-6LE2R5E*	–	–
	3-phase	U-4LE2R8	U-5LE2R8	U-6LE2R8	–	–
		U-4LE2R8E*	U-5LE2R8E*	U-6LE2R8E*	–	–
LE1	3-phase	–	–	–	U-8LE1R8	U-10LE1R8
		–	–	–	U-8LE1R8E*	U-10LE1R8E*
ME2	3-phase	–	–	–	U-8ME2R8	U-10ME2R8
		–	–	–	U-8ME2R8E*	U-10ME2R8E*
MF3	3-phase	–	–	–	U-8MF3R7	U-10MF3R7

Outdoor unit type		12 HP	14 HP	16 HP	18 HP	20 HP
ME2	3-phase	U-12ME2R8	U-14ME2R8	U-16ME2R8	U-18ME2R8	U-20ME2R8
		U-12ME2R8E*	U-14ME2R8E*	U-16ME2R8E*	U-18ME2R8E*	U-20ME2R8E*
MF3	3-phase	U-12MF3R7	U-14MF3R7	U-16MF3R7	–	–

* Salt-Air Damage Resistant Specifications

Asia

Outdoor unit type		4 HP	5 HP	6 HP	8 HP	10 HP
LE2	1-phase	U-4LE2H4	U-5LE2H4	U-6LE2H4	–	–
		U-4LE2H4E*	U-5LE2H4E*	U-6LE2H4E*	–	–
	3-phase	U-4LE2H7	U-5LE2H7	U-6LE2H7	–	–
		U-4LE2H7E*	U-5LE2H7E*	U-6LE2H7E*	–	–
LE1	3-phase	–	–	–	U-8LE1H7	U-10LE1H7
		–	–	–	U-8LE1H7E*	U-10LE1H7E*
ME2	3-phase	–	–	–	U-8ME2H7	U-10ME2H7
		–	–	–	U-8ME2H7E*	U-10ME2H7E*

Outdoor unit type		12 HP	14 HP	16 HP	18 HP	20 HP
ME2	3-phase	U-12ME2H7	U-14ME2H7	U-16ME2H7	U-18ME2H7	U-20ME2H7
		U-12ME2H7E*	U-14ME2H7E*	U-16ME2H7E*	U-18ME2H7E*	U-20ME2H7E*

* Salt-Air Damage Resistant Specifications

Specifications

Indoor unit

Middle Static Pressure Duct





Model Name		S-15MF3E5AN	S-22MF3E5AN	S-28MF3E5AN	S-36MF3E5AN	S-45MF3E5AN	S-56MF3E5AN
Power source		220 - 230 - 240 V~ 50 - 60 Hz					
Cooling capacity	kW	1.5	2.2	2.8	3.6	4.5	5.6
	BTU/h	5,100	7,500	9,600	12,300	15,400	19,100
	Sensible kW	1.4	2.0	2.3	2.8	3.4	4.1
	Latent kW	0.1	0.2	0.5	0.8	1.1	1.5
Heating capacity	kW	1.7	2.5	3.2	4.2	5.0	6.3
	BTU/h	5,800	8,500	10,900	14,300	17,100	21,500
Cooling electric power input*	kW	0.060	0.060	0.060	0.060	0.060	0.089
Heating electric power input*	kW	0.060	0.060	0.060	0.060	0.060	0.089
Sound pressure level **	High dB(A)	31	31	31	31	31	35
	Medium dB(A)	28	28	28	28	28	32
	Low dB(A)	20	20	20	20	20	24
Sound power level **	High dB(A)	54	54	54	54	54	58
	Medium dB(A)	51	51	51	51	51	55
	Low dB(A)	43	43	43	43	43	47
Unit dimensions (H×W×D)	mm	250×800×730	250×800×730	250×800×730	250×800×730	250×800×730	250×800×730
Net weight	kg	26	26	26	26	26	26

Operation condition temperature range

- Cooling mode : 14°C~25°C WB
- Heating mode : 16°C~30°C DB

* In the case of nanoe™ X “OFF”

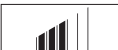
** Fan speed display on the remote controller

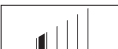
High	: 	(CZ-RTC4),		(CZ-RTC5B, CZ-RTC6 series)
Medium	: 	(CZ-RTC4),		(CZ-RTC5B, CZ-RTC6 series)
Low	: 	(CZ-RTC4),		(CZ-RTC5B, CZ-RTC6 series)

Specifications

Indoor unit

Middle Static Pressure Duct





Model Name		S-60MF3E5AN	S-73MF3E5AN	S-90MF3E5AN	
Power source		220 - 230 - 240 V~ 50 - 60 Hz			
Cooling capacity	kW	6.0	7.3	9.0	
	BTU/h	20,500	24,900	30,700	
	Sensible kW	4.6	5.3	6.6	
	Latent kW	1.4	2.0	2.4	
Heating capacity	kW	7.1	8.0	10.0	
	BTU/h	24,200	27,300	34,100	
Cooling electric power input*	kW	0.079	0.079	0.136	
Heating electric power input*	kW	0.079	0.079	0.136	
Sound pressure level **	High	dB(A)	31	31	35
	Medium	dB(A)	28	28	33
	Low	dB(A)	23	23	25
Sound power level **	High	dB(A)	54	54	58
	Medium	dB(A)	51	51	56
	Low	dB(A)	46	46	48
Unit dimensions (H×W×D)	mm	250×1,000×730	250×1,000×730	250×1,000×730	
Net weight	kg	31	31	31	

Operation condition temperature range

- Cooling mode : 14°C~25°C WB
- Heating mode : 16°C~30°C DB

* In the case of nanoe™ X “OFF”

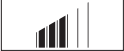
** Fan speed display on the remote controller

High	:		(CZ-RTC4),		(CZ-RTC5B, CZ-RTC6 series)
Medium	:		(CZ-RTC4),		(CZ-RTC5B, CZ-RTC6 series)
Low	:		(CZ-RTC4),		(CZ-RTC5B, CZ-RTC6 series)

Specifications

Indoor unit

Middle Static Pressure Duct





Model Name		S-106MF3E5AN	S-112MF3E5AN	S-140MF3E5AN	S-160MF3E5AN
Power source		220 - 230 - 240 V~ 50 - 60 Hz			
Cooling capacity	kW	10.6	11.2	14.0	16.0
	BTU/h	36,200	38,200	47,800	54,600
	Sensible kW	8.2	8.5	9.9	11.0
	Latent kW	2.4	2.7	4.1	5.0
Heating capacity	kW	11.4	12.5	16.0	18.0
	BTU/h	38,900	42,700	54,600	61,400
Cooling electric power input*	kW	0.146	0.265	0.265	0.330
Heating electric power input*	kW	0.146	0.265	0.265	0.330
Sound pressure level **	High dB(A)	36	41	41	43
	Medium dB(A)	32	36	36	37
	Low dB(A)	27	32	32	33
Sound power level **	High dB(A)	59	64	64	66
	Medium dB(A)	55	59	59	60
	Low dB(A)	50	55	55	56
Unit dimensions (H×W×D)	mm	250×1,400×730	250×1,400×730	250×1,400×730	250×1,400×730
Net weight	kg	40	40	40	40

Operation condition temperature range

- Cooling mode : 14°C~25°C WB
- Heating mode : 16°C~30°C DB

* In the case of nanoe™ X “OFF”

** Fan speed display on the remote controller

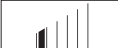
High	:  (CZ-RTC4),  (CZ-RTC5B, CZ-RTC6 series)
Medium	:  (CZ-RTC4),  (CZ-RTC5B, CZ-RTC6 series)
Low	:  (CZ-RTC4),  (CZ-RTC5B, CZ-RTC6 series)

Specifications

Outdoor unit

mini VRF (Type LE1, LE2)

2WAY VRF (Type ME2)

3WAY VRF (Type MF3)

NOTE

Refer to the Operating Instructions attached to the outdoor unit.

India Only

Information on hazardous constituents as specified in sub-rule 1 of rule 16 (1) in electrical and electronic equipment. Declaration of Conformity with the requirements of the E-Waste (Management) Amendment Rules 2018 with the rule 16 (1) limits with respect to Lead, Mercury, Cadmium, Hexavalent chromium, Polybrominated biphenyls, Polybrominated diphenyl ethers. The content of hazardous substance with the exemption of the applications listed in SCHEDULE II of the E-Waste (Management) Amendment Rules 2018 :

1. Lead (Pb) – not over 0.1% by weight;
2. Cadmium (Cd) – not over 0.01% by weight;
3. Mercury (Hg) – not over 0.1% by weight;
4. Hexavalent chromium (Cr⁶⁺) – not over 0.1% by weight;
5. Polybrominated biphenyls (PBBs) – not over 0.1% by weight;
6. Polybrominated diphenyl ethers (PBDEs) – not over 0.1% by weight.



For the purpose of recycling to facilitate effective utilization of resources, please return this product to a nearby authorized collection center, registered dismantler or recycler, or Panasonic service center when disposing of this product.

Customer care number (Toll free) : 1800 103 1333 , 1800 108 1333

Please see the Panasonic website for further information on collection centers, etc. or call the customer care toll-free number <http://www.panasonic.com/in/corporate/sustainability/panasonic-india-i-recycle-program.html>

Do's & Don'ts: E-waste (Management) Amendment Rules 2018

S.No.	Do's	Don'ts
1.	All electrical and electronic products are required to be handed over only to the Authorized recycler.	The product should not be opened by the user himself / herself, but only by authorized service personnel.
2.	The product should be handed over only to authorized recycler for disposal.	The product is not meant for re-sale to any unauthorized agencies / scrap dealers / kabariwalas.
3.	Keep the product in an isolated area, after it becomes non-functional / unrepairable so as to prevent its accidental breakage.	The product is not meant for mixing into household waste stream.
4.	Refer to Operating Instructions for handling of end of life products.	Do not keep any replaced spare part(s) from the product in an exposed area.
5.	Always dispose products that have reached end of life at Panasonic India Authorized Service Centre.	Do not donate old electronic items to anybody. Do not dispose your product in garbage bins along with municipal waste that ultimately reaches landfill.
6.	Wherever possible or as instructed, separate the packaging material according to responsible waste disposal options and sorting for recycling.	Do not give e-waste to informal and unorganized sectors like Local Scrap Dealers / Rag Pickers.

Contact in the UK
Panasonic UK,
a branch of Panasonic Marketing Europe GmbH,
Maxis 2, Western Road, Bracknell, Berkshire, RG12 1RT

Panasonic Corporation
<http://www.panasonic.com>

© Panasonic Corporation 2023

Authorised representative in EU
Panasonic Testing Centre
Panasonic Marketing Europe GmbH
Winsbergring 15, 22525 Hamburg, Germany

WEB-ACXF55-35940-00-EN
DC0223-0